

## Rectifier Diodes

## S3ABF THRU S3MBF

## FEATURES

- For surface mounted applications
- Low profile package
- Glass Passivated Chip Junction
- Easy to pick and place
- Lead free in comply with EU RoHS 2011/65/EU directives

## PINNING

PIN	DESCRIPTION
1	Cathode
2	Anode

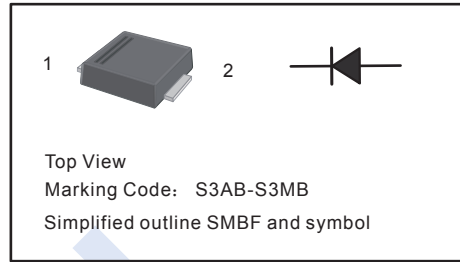

## Maximum Ratings and Electrical characteristics

Ratings at 25 °C ambient temperature unless otherwise specified.

Single phase half-wave 60 Hz, resistive or inductive load, for capacitive load current derate by 20 %.

Parameter	Symbols	S3ABF	S3BBF	S3DBF	S3GBF	S3JBF	S3KBF	S3MBF	Units
Maximum Repetitive Peak Reverse Voltage	$V_{RRM}$	50	100	200	400	600	800	1000	V
Maximum RMS voltage	$V_{RMS}$	35	70	140	280	420	560	700	V
Maximum DC Blocking Voltage	$V_{DC}$	50	100	200	400	600	800	1000	V
Maximum Average Forward Rectified Current at $T_c = 115\text{ °C}$	$I_{F(AV)}$	3							A
Peak Forward Surge Current 8.3 ms Single Half Sine Wave Superimposed on Rated Load	$I_{FSM}$	100							A
Maximum Instantaneous Forward Voltage at 3 A	$V_F$	1.1							V
Maximum DC Reverse Current at Rated DC Blocking Voltage $T_a = 25\text{ °C}$ $T_a = 125\text{ °C}$	$I_R$	5 150							$\mu\text{A}$
Typical Junction Capacitance <sup>(1)</sup>	$C_j$	35							pF
Typical Thermal Resistance <sup>(2)</sup>	$R_{\theta JA}$ $R_{\theta JC}$	45 15							$^{\circ}\text{C/W}$
Operating and Storage Temperature Range	$T_j, T_{stg}$	-55 ~ +150							$^{\circ}\text{C}$

(1) Measured at 1 MHz and applied reverse voltage of 4 V<sub>DC</sub>.

(2) P.C.B. mounted with 2.0" X 2.0" (5X5 cm) copper pad areas.

# Rectifier Diodes

## S3ABF THRU S3MBF

■ Typical Characteristics

Fig.1 Forward Current Derating Curve

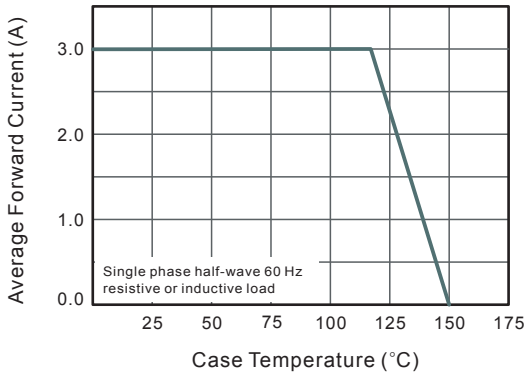

Fig.2 Typical Reverse Characteristics

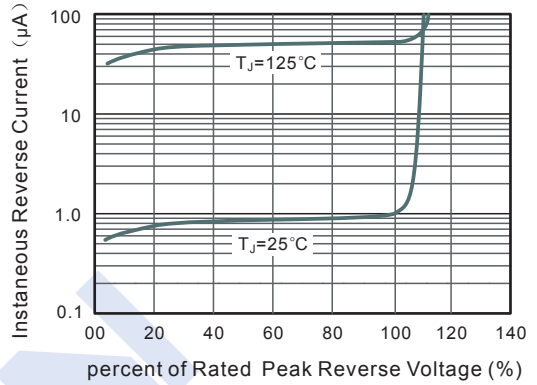

Fig.3 Typical Forward Characteristic

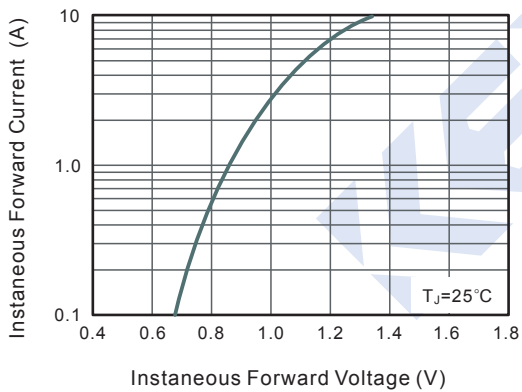

Fig.4 Typical Junction Capacitance

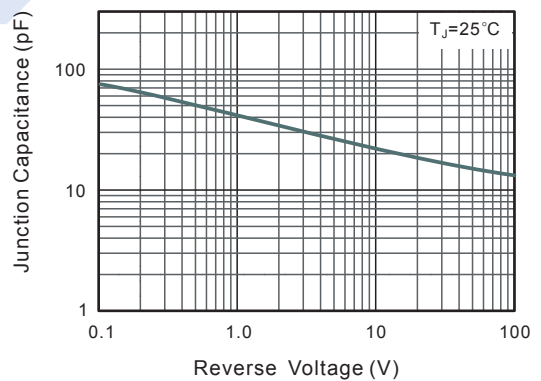
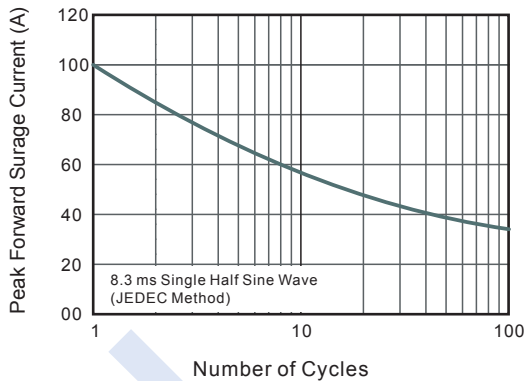

Fig.6 Maximum Non-Repetitive Peak Forward Surge Current



## Rectifier Diodes

### S3ABF THRU S3MBF

#### PACKAGE OUTLINE

Plastic surface mounted package; 2 leads

SMBF

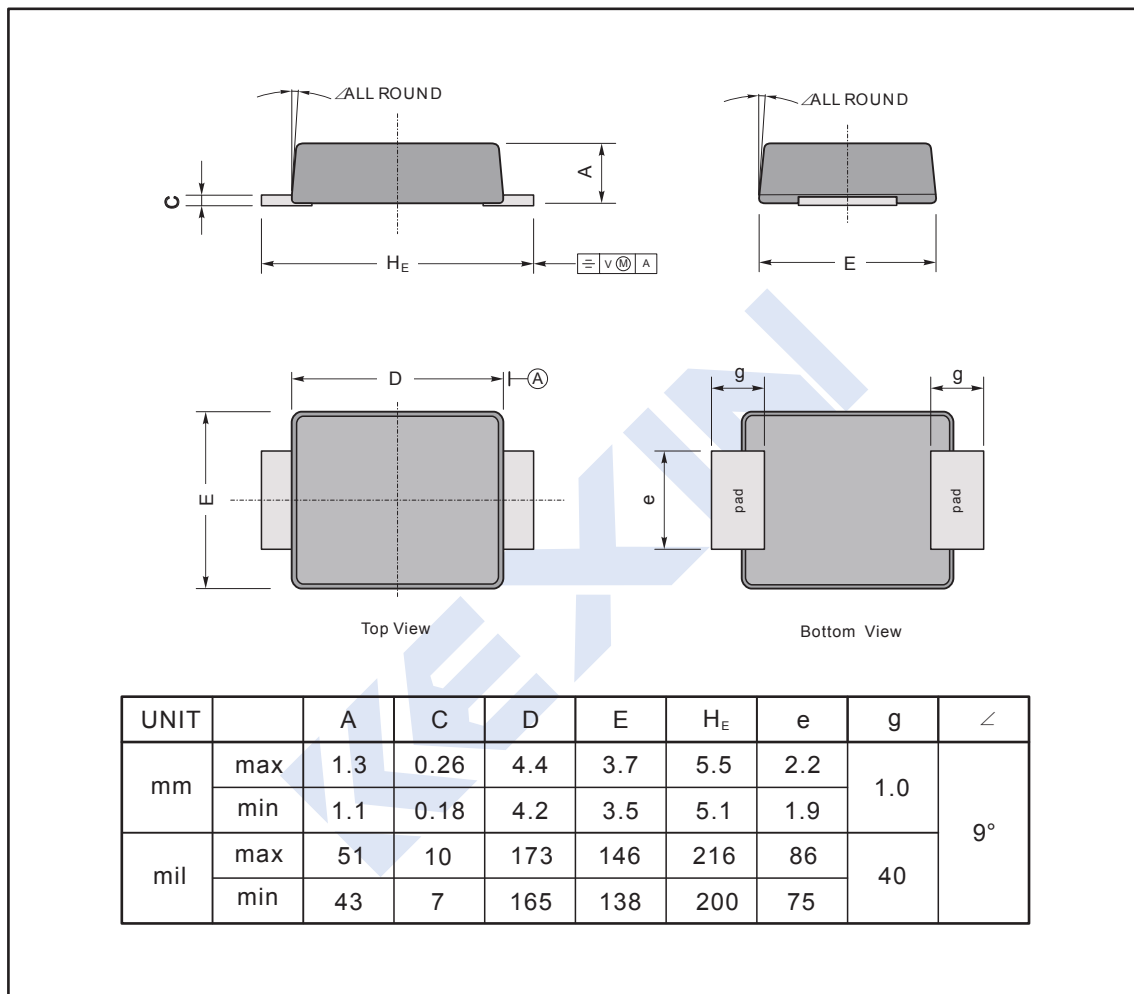

#### The recommended mounting pad size

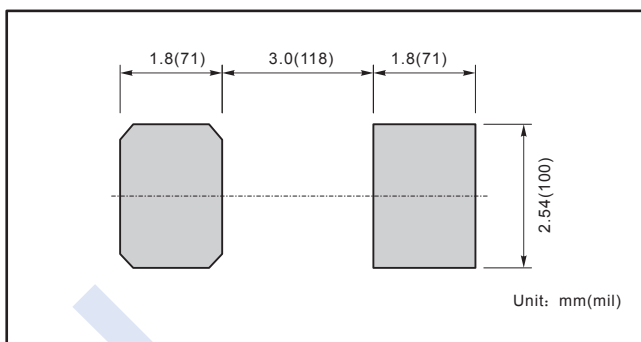

#### Marking

Type number	Marking code
S3ABF	S3AB
S3BBF	S3BB
S3DBF	S3DB
S3GBF	S3GB
S3JBF	S3JB
S3KBF	S3KB
S3MBF	S3MB